



TECHNICAL DATASHEET

TAB AGM STOP&GO AG70

ORDER INFORMATION

TAB ID
213070

Short Code
AG70

DIN Marking
L3 AGM

EAN Code
3838807008731

Quantity per EU/CNT pallet
51/80 pcs

TECHNOLOGY

Primary Function
Advanced Start/Stop Functionality

Battery Technology
AGM - Absorbent Glass Mat

Grid Type (pos/neg)
Casted/Concasted

Grid Alloy (pos/neg)
Ca/Ca

Separator
GM

Electrolyte (g/cm³)
1,3

TECHNICAL INFORMATION

Voltage (V)
12

Capacity C20 (Ah)
70

CCA -18°C EN (A)
760

RC (min)
130

LxWxH (mm)
278x175x190

Total Weight (kg)
20.5

BOX DESIGN

Box Type
L3

Cover Type
Sealed

Colour
Black

Layout
0

BHD
B13

Terminal
1

DRAWING

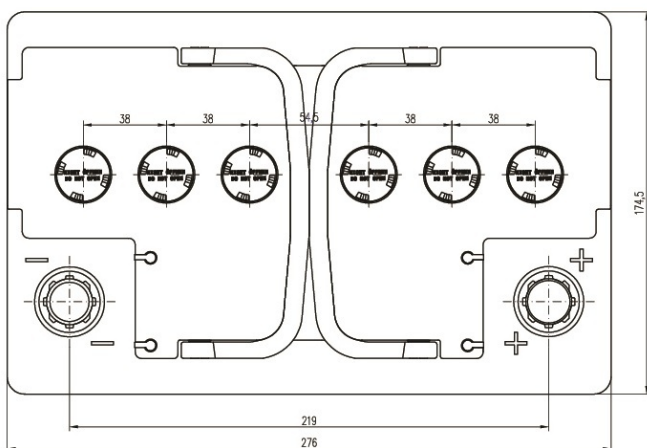
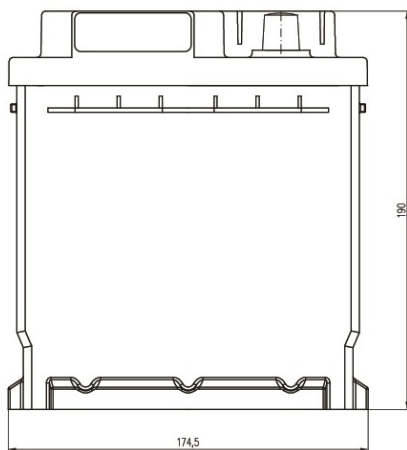
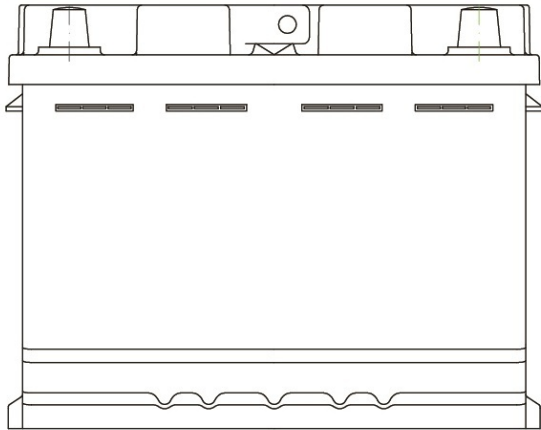

BHD

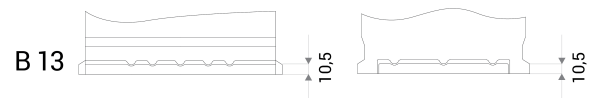

LAYOUT



TERMINAL



TECHNICAL DATASHEET

TAB AGM STOP&GO AG70